

Varenummer: 201241382A
Beskrivelse: E+G Stangmagnet m/gevindtap GN 52.4-AN-6-M3-E
Alu, Nikkel, Kobolt - 450° C, 2N

Mål

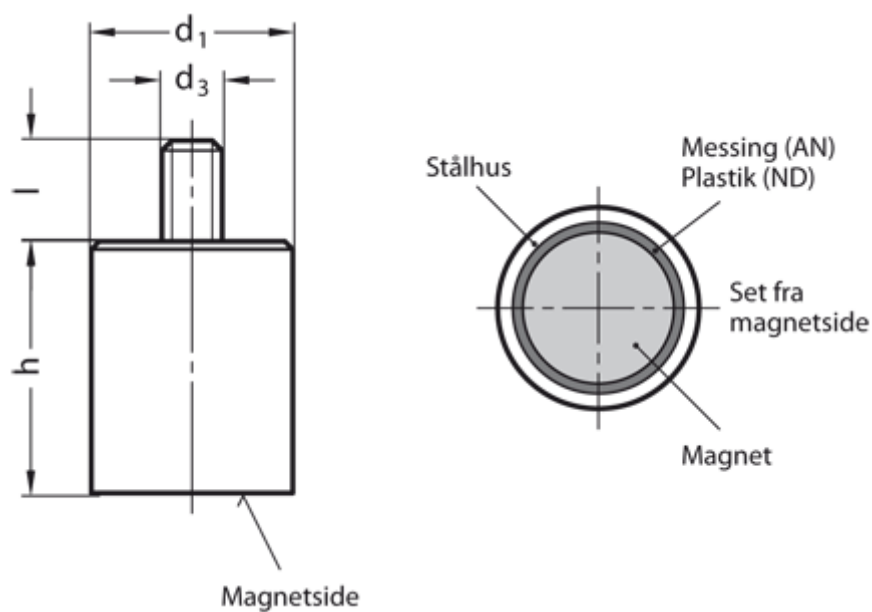

d1	= 6
d3	= M3
h	= 20 ±0,2
Holdekraft N	= 2.0
l	= 7
Materiale	= AN Alu, Nikkel, Kobolt - 450° C